

# SEALS+DIRECT

www.sealsdirect.co.uk

DESCRIPTION  
 CARAVAN / MOTORHOME OPENING WINDOW SEAL  
 LARGE BULB C/W GREY INSERT

ORDER CODE  
**CS 784G**

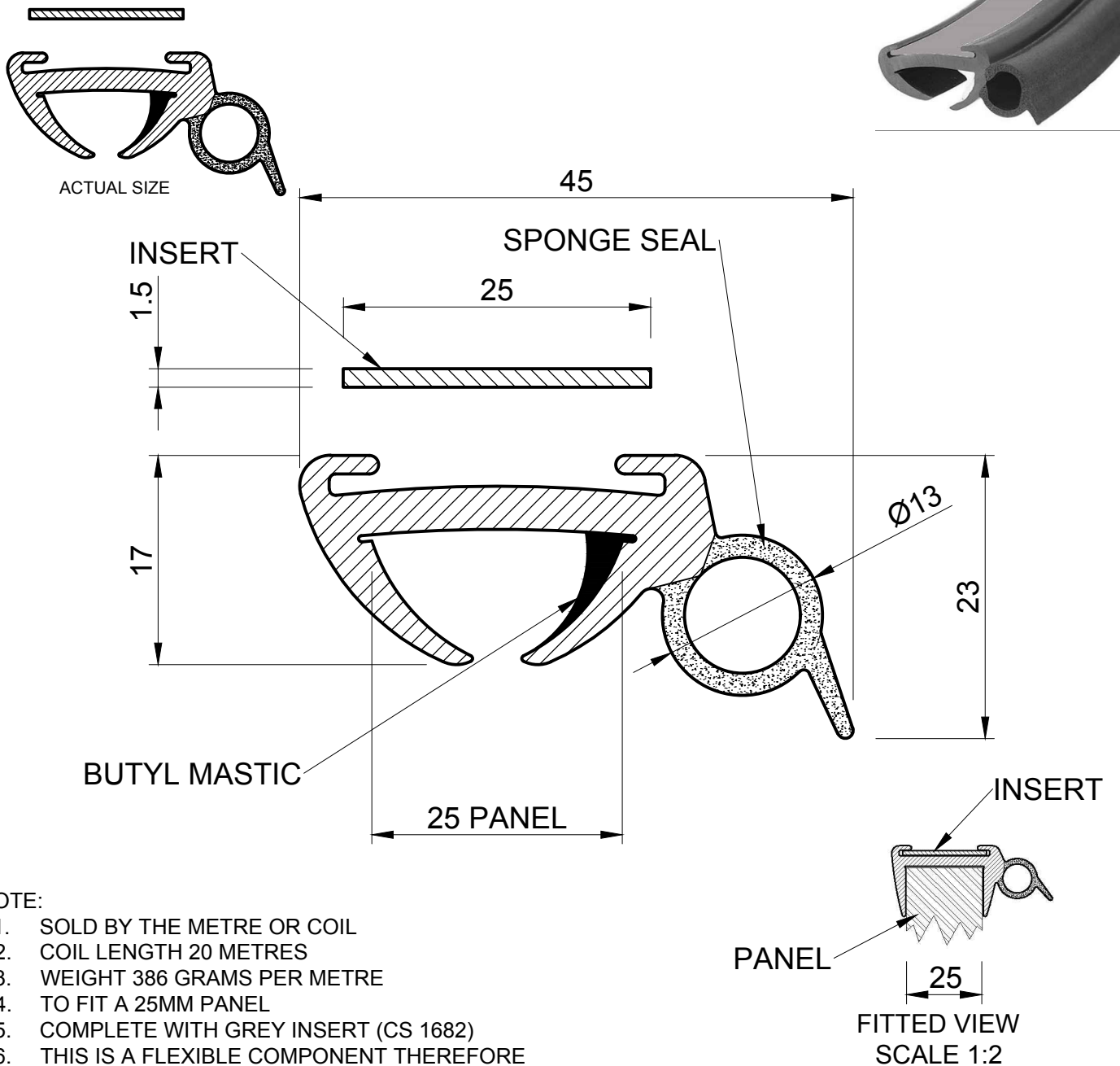

**NOTE:**

1. SOLD BY THE METRE OR COIL
2. COIL LENGTH 20 METRES
3. WEIGHT 386 GRAMS PER METRE
4. TO FIT A 25MM PANEL
5. COMPLETE WITH GREY INSERT (CS 1682)
6. THIS IS A FLEXIBLE COMPONENT THEREFORE OVERALL DIMENSIONS ARE APPROXIMATE

MATERIAL (REFER TO OUR DATA SHEET FOR FULL TECHNICAL DATA)  
 BLACK EPDM 70° SHORE A, SPONGE SEAL, BUTYL MASTIC

TOLERANCE  
 TO BS 3734 CLASS E3

ISSUE DATE  
**08.12.16**

**Seals + Direct Ltd**

Unit 6, Milton Business Centre, Wick Drive, New Milton, Hants, BH25 6RH  
 Tel: 01425 617722 Fax: 01425 610967 E-mail: sales@sealsplusdirect.co.uk

Reg. No 4989100

SCALE  
**2 : 1**

PROJECTION

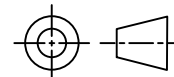

DIMENSIONS IN MM

©SEALS + DIRECT LTD

This information and our technical advice, whether verbal, in writing or by way of trials, is given in good faith but without warranty. This also applies where proprietary rights are involved. Our advice does not release you from the obligations to check its validity and to test our products as to their suitability for the intended use. The storage, application and use of our products are beyond our control and, therefore, entirely your own responsibility. Our products are sold in accordance with our General Conditions of Sale. The information contained within this drawing is subject to change without notice.