

# SEALS+DIRECT

www.sealsdirect.co.uk

DESCRIPTION

END CAP FOR ALF 1019

ORDER CODE

**ALFE 1020**

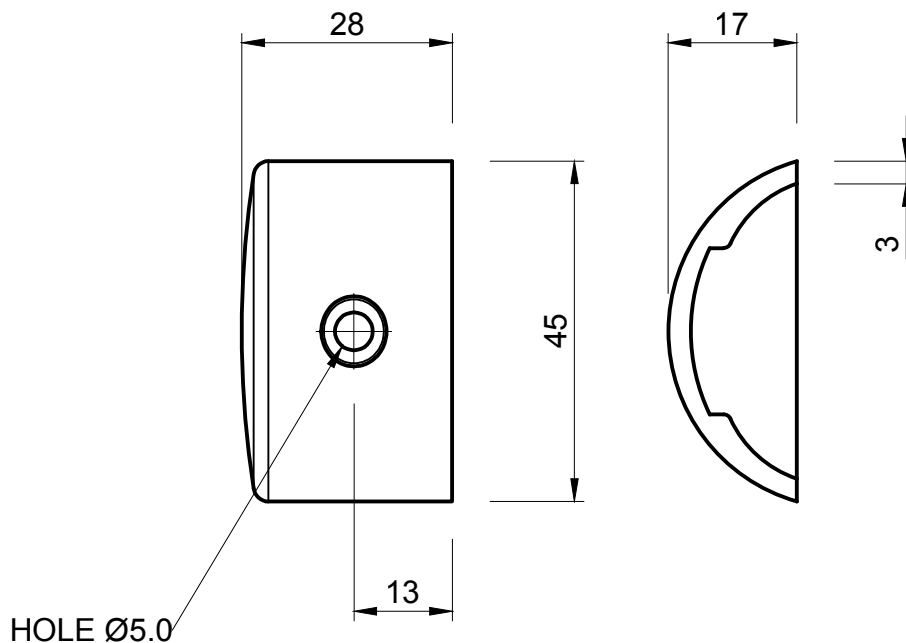
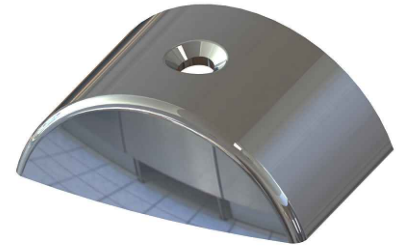

NOTE:

1. SOLD INDIVIDUALLY
2. WEIGHT 24 GRAMS EACH

MATERIAL (REFER TO OUR DATA SHEET FOR FULL TECHNICAL DATA)  
POLISHED 316 STAINLESS STEEL

TOLERANCE  
REFERENCE ONLY

ISSUE DATE  
**26.01.17**

**Seals + Direct Ltd**

Unit 6, Milton Business Centre, Wick Drive, New Milton, Hants, BH25 6RH  
Tel: 01425 617722 Fax: 01425 610967 E-mail: sales@sealsplusdirect.co.uk

Reg. No 4989100

SCALE  
**1:1**

PROJECTION

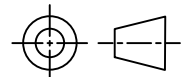

This information and our technical advice, whether verbal, in writing or by way of trials, is given in good faith but without warranty. This also applies where proprietary rights are involved. Our advice does not release you from the obligations to check its validity and to test our products as to their suitability for the intended use. The storage, application and use of our products are beyond our control and, therefore, entirely your own responsibility. Our products are sold in accordance with our General Conditions of Sale. The information contained within this drawing is subject to change without notice.

DIMENSIONS IN MM

©SEALS + DIRECT LTD